

CLEARSTREAM HYBRID²

ASSEMBLY INSTRUCTIONS

PARTS:

- (1) Side Frame (Left)
- (1) Side Frame (Right)
- (1) Bottom Frame
- (1) Top Frame
- (2) Back Grid
- (2) Clear Sliding Panel
- (1) Header Wire
- (2) Header Graphic
- (2) Lid
- (4) Casters
- (8) Bolts
- (2) 40" x 45" Clear Bag

TOOLS REQUIRED:

Phillips Screwdriver

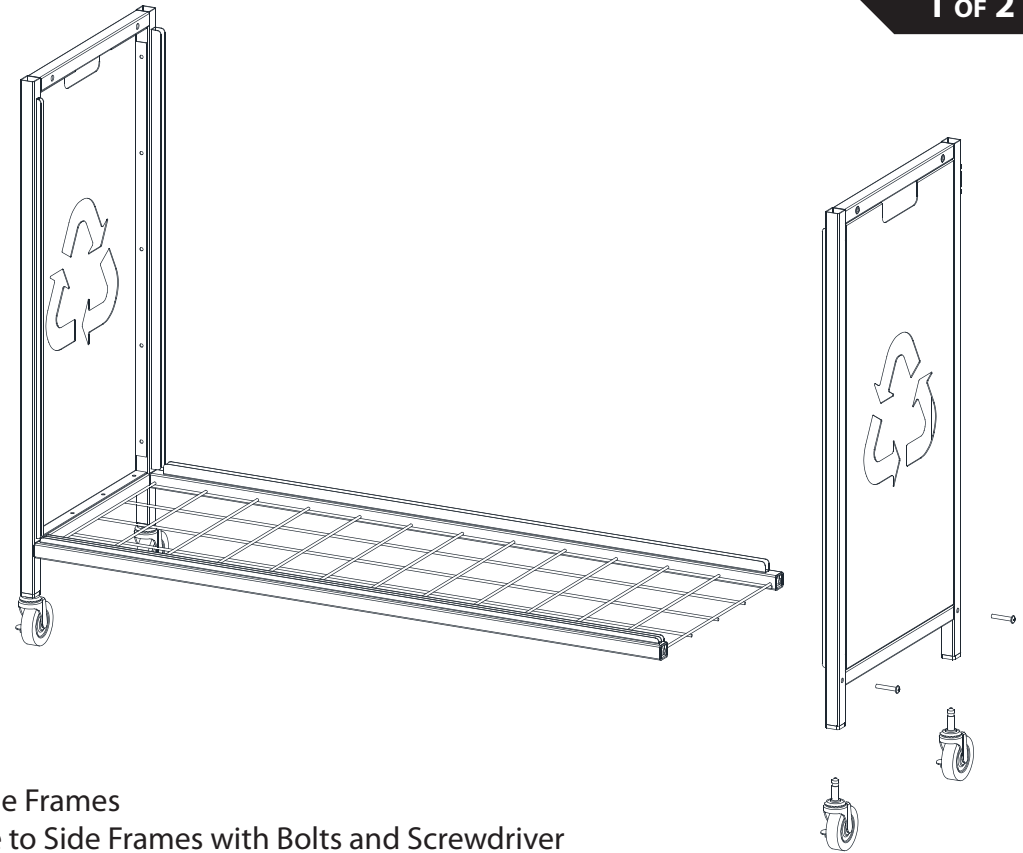
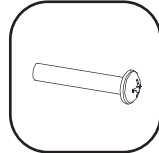
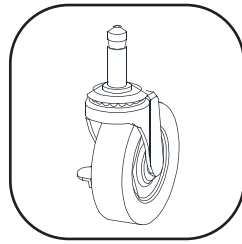

- 1** (A) Insert casters into Side Frames
(B) Attach Bottom Frame to Side Frames with Bolts and Screwdriver

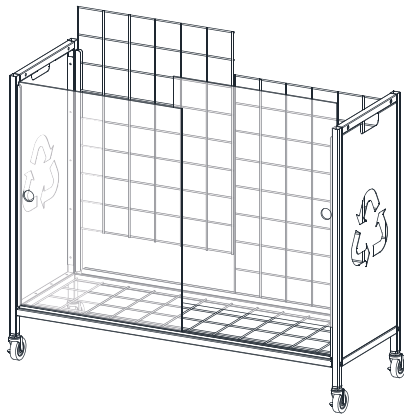

- 2** (A) Insert Back Grids into back channels
(B) Insert Clear Sliding Panels into front channels

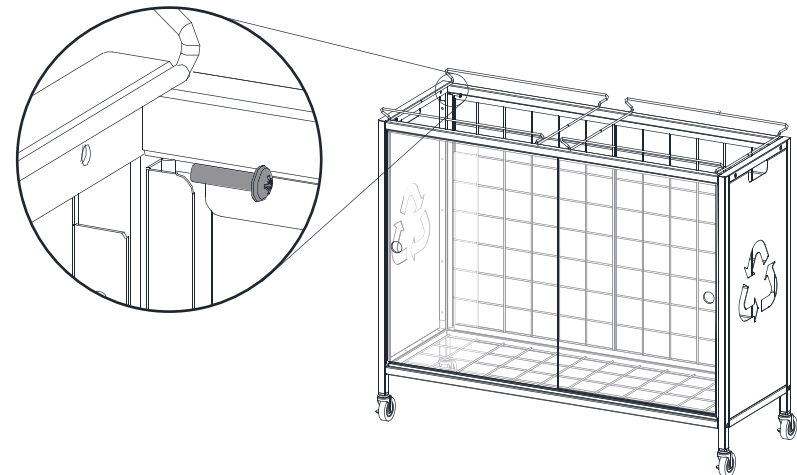

- 3** Attach Top Frame to Side Frames with Bolts

CLEARSTREAM HYBRID²

ASSEMBLY INSTRUCTIONS

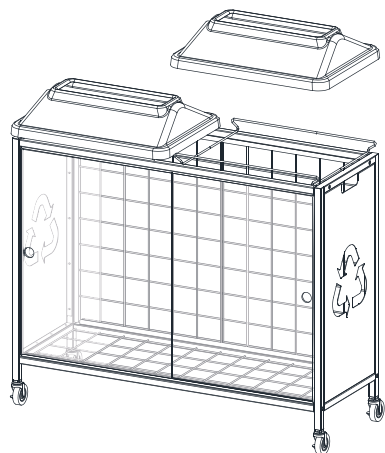

4

- (A) Install 40"x45" Clear Bags (not pictured)
- (B) Attach Lids to Top Frame

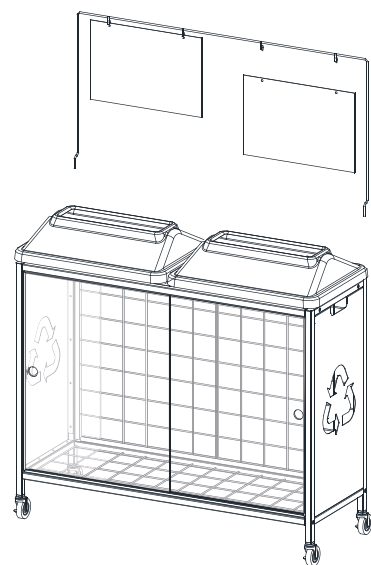

5

- (A) Insert Header Wire into weld slips on back of Side Frames
- (B) Hang Header Graphics from Header Wire

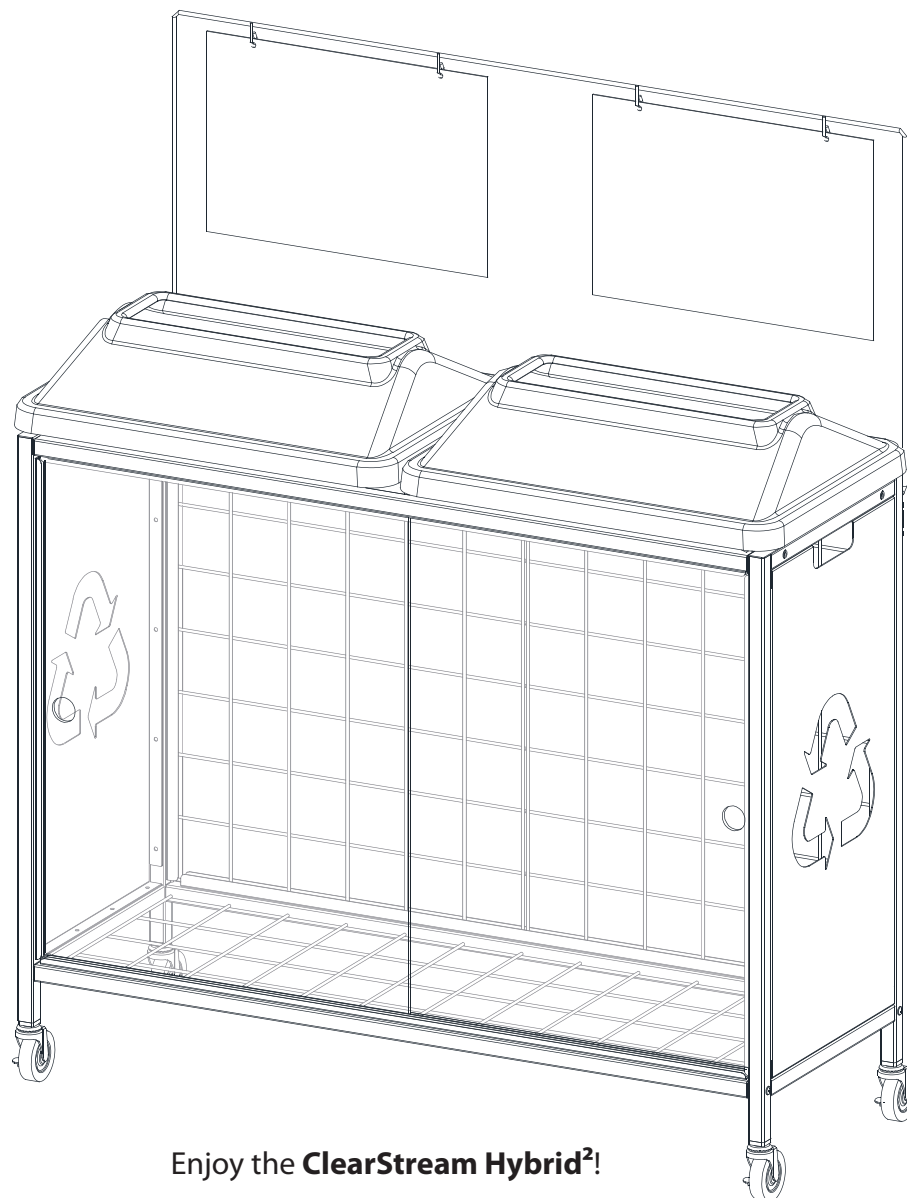

Enjoy the **ClearStream Hybrid²**!